

Courbes de charges / Lastkurven / Load curves / Curvas de cargas / Curve di carico
 Curvas de carga / Кривые нагрузок

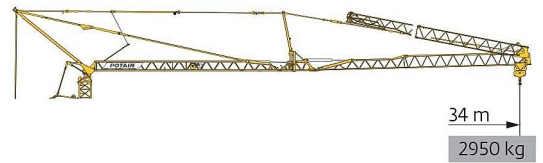

50 m	3,5	▶	13,2	14	16	18	20	22	22,7	23	24	26	28	30	32	34	36	38	40	42	44	46	48	50	m					
▲▲▲	▲▲▲		8000	7400	6200	5400	4700	4200	-	3900	3700	3400	3100	2800	2600	2400	2200	2050	1900	1800	1700	1600	1500	1400	kg					
														4000	3900	3700	3400	3100	2800	2600	2400	2200	2050	1900	1800	1700	1600	1500	1400	kg
47 m	3,5	▶	14,1	15	16	18	20	22	24	24,4	25	26	28	30	32	34	36	38	40	42	44	46	47	m						
▲▲▲	▲▲▲		8000	7400	6800	5900	5100	4600	4100	-	3900	3700	3400	3100	2850	2600	2450	2250	2100	2000	1850	1750	1700	kg						
														4000	3900	3700	3400	3100	2850	2600	2450	2250	2100	2000	1850	1750	1700	kg		
42 m	3,5	▶	15,3	16	18	20	22	24	25	26	26,7	27	28	30	32	34	36	38	40	42	m									
▲▲▲	▲▲▲		8000	7600	6500	5700	5100	4600	4300	4100	-	3900	3800	3500	3200	2950	2750	2550	2400	2250	kg									
														4000	3900	3800	3500	3200	2950	2750	2550	2400	2250	kg						
33,5 m	3,5	▶	18,6	20	22	24	25	26	27	28	30	32	32,8	33,5	m															
▲▲▲	▲▲▲		8000	7300	6500	5900	5600	5300	5100	4900	4500	4100	-	3900	kg															
														4000	3900	kg														

50 m	3,5	▶	15,3	16	18	20	22	24	26	26,7	28	30	32	34	m				
▲▲▲	▲▲▲		8000	7600	6500	5700	5100	4600	4100	-	3800	3500	3200	2950	kg				
42 m	3,5	▶												4000	3800	3500	3200	2950	kg

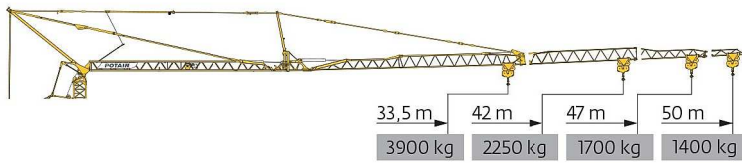
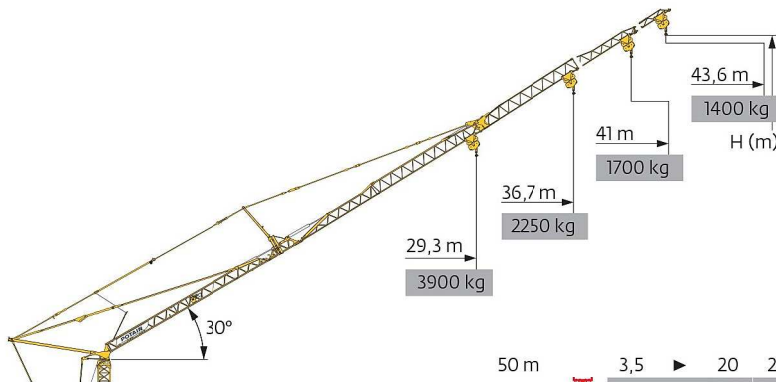

▲▲▲		50 m	47 m	42 m	33,5 m
H+3	!	61	59,4	-	-
H+2	!	58	56,4	-	-
		55	53,4	50,7	46,1
H+1		52	50,4	47,7	43,1
		49	47,4	44,7	40,1
H+0		46	44,4	41,7	37,1

50 m	3,5	▶	20	22	24	26	28	30	32	34	36	38	40	42	43,6	m					
▲▲▲	▲▲▲		4000	3500	3200	2850	2600	2350	2150	2000	1850	1700	1600	1500	1400	kg					
47 m	3,5	▶	21,4	22	24	26	28	30	32	34	36	38	41	m							
▲▲▲	▲▲▲		4000	3900	3500	3100	2850	2600	2400	2200	2050	1900	1700	kg							
42 m	3,5	▶												23,5	26	28	30	32	34	36,7	m
▲▲▲	▲▲▲													4000	3500	3200	2950	2700	2500	2250	kg
33,5 m	3,5	▶												28,8	29,3	m					
▲▲▲	▲▲▲													4000	3900	kg					

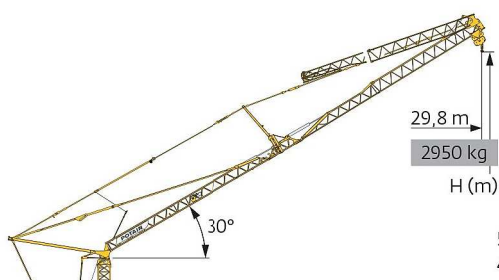

▲▲▲	50 m
▲▲▲	47 m
▲▲▲	42 m
H+2	46,4
H+1	43,4
H+0	40,4
H+0	37,4

50 m	3,5	▶	23,4	24	26	28	29,8	m					
47 m	3,5	▶						4000	3900	3500	3200	2950	kg
42 m	3,5	▶						4000	3900	3500	3200	2950	kg

400 V - 50 Hz 480 V - 60 Hz												ch - PS hp	kW	
	33 LVF 20 Optima	m/min	3,2	16	34	53	63	1,6	8	17	26,5	31,5	29,5	22
		kg	4000	4000	4000	2000	1000	8000	8000	8000	4000	2000		
	5 DVF 5	m/min	15 - 30 - 39 (2000 → 8000 kg) 15 - 30 - 55 (200 → 2000 kg) 15 - 30 - 70 (0 → 200 kg)									5,4	4	
	RVF 161 Optima+	tr/min U/min rpm	0 → 0,8									7,5	5,5	
	TVF 124	m/min	25									2 x 4	2 x 3	

IEC 60204-32	kVA
400 V (+10% -10%) 50 Hz / 480 V (+6% -10%) 60 Hz	31 → 19 kVA 35 → 22 kVA

33 LVF 20 Optima

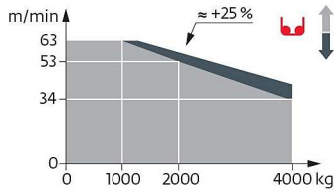

Montage / Montage / Erection / Montaje / Montaggio
 Montagem / Монтаж

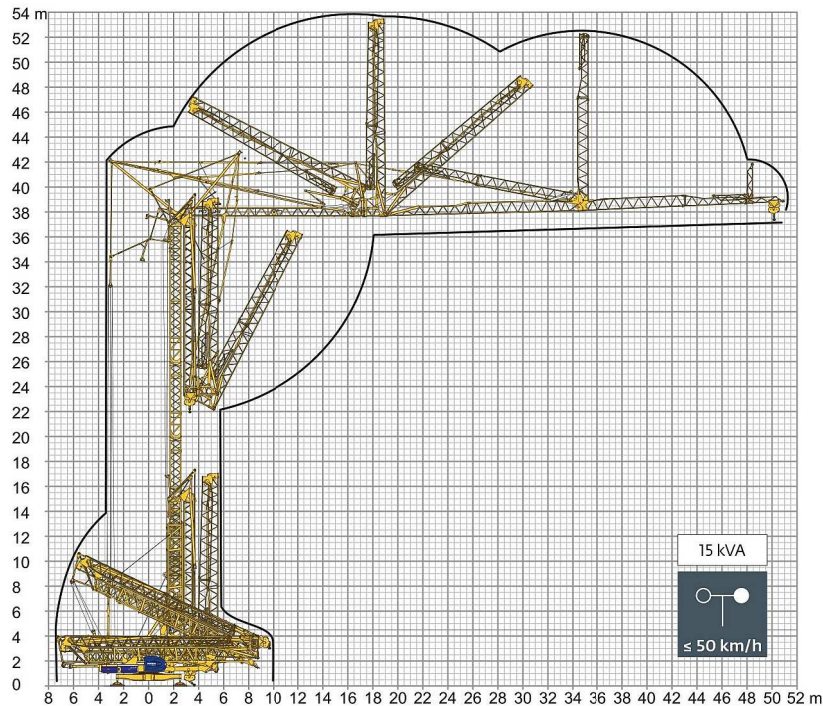

Transport / Transport / Transport / Transporte / Trasporto
 Transporte / Транспортировка

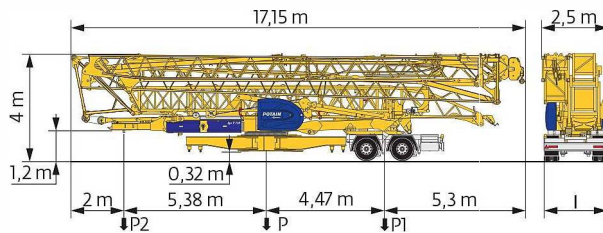

	km/h	l (m)	P (kg)	P1 (kg)	P2 (kg)
SL121/S215M	25	2,4	30100	19300	10800
SL122/J215M (EBS) RCE e2°2007/46°0493°01 WVTA e2°2007/46°0493°01	80	2,45	30000	19200	10800

	FR	DE	EN	ES	IT	PT	RU
R	Rayon de giration	Schwenk radius	Rear slewing radius	Radio de giro	Raggio di rotazione	Raio de rotação	Задний габарит
i	Nous consulter	AufAnfrage	Consult us	Consultarnos	Consultateci	Consultarnos	Проконсультируйтесь у нас
●	Réactions en service	Reaktionskräfte in Betrieb	Reactions in service	Reacciones en servicio	Reazioni in servizio	Reacções em serviço	Реакция при работе
■	Réactions hors service	Reaktionskräfte außer Betrieb	Reactions out of service	Reacciones fuera de servicio	Reazioni fuori servizio	Reacções fora de serviço	Реакция в покое
⚖	Poids à vide, sans lest, sans trains de transport, avec flèche maxi. et hauteur standard.	Gewicht ohne Last, ohne Ballast, ohne Transportachsen, mit max. Auslager und Standardhöhe	Weight without load, without ballast, without transport axes, with max. jib and standard height	Peso en vacío, sin lastre, sin trenes de transporte con flecha y altura estándar	Peso a vuoto, senza zavorra, senza assali di trasporto, con braccio max e altezza standard.	Peso em vazio, sem lastro, sem eixos de transporte com lança máxima e altura standard.	Вес без груза, без балласта, без осей для транспортировки, с максимальным вылетом стрелы и стандартной высотой
⚖	Poids total du lest	Ballast-Gesamtgewicht	Total ballastweight	Peso total del lastre	Peso totale della zavorra	Peso total do lastro	Общий вес балласта
□	Équipements standards	Standardausrüstungen	Standard equipment	Equipamiento de serie	Equipaggiamento standard	Equipamento de série	Стандартное оборудование
□	Équipements optionnels	Sonderausrüstungen	Options	Equipamiento opcional	Equipaggiamento in opzione	Equipamento opcional	Дополнительное оборудование (опция)
⬆	Levage	Heben	Hoisting	Elevación	Sollevamento	Elevação	Подъем
➡	Distribution	Katzfahren	Trolleying	Distribución	Distribuzione	Distribuição	Перемещение по стреле
⬅	Orientation	Schwenken	Slewing	Orientación	Rotazione	Rotação	Поворот
➡	Translation	Kranfahren	Travelling	Traslación	Traslazione	Translação	Перемещение крана
⚡	Puissance requise	Erforderliche Leistung	Required power	Potencia Necesaria	Potenza richiesta	Potência Necessária	Потребляемая мощность
⌚	Fonction Power Control : vitesses treuils adaptées à la puissance disponible	Funktion Power Control: Geschwindigkeiten der Triebwerkwerden an die verfügbare Leistung angepasst	Power Control Function: winch speeds adapted to the available power	Función Power Control: marchas de los cabrestantes adaptadas a la potencia disponible	Funzione Power Control: velocità degli argani adattate alla potenza disponibile	Função Power Control: velocidades de guincho adaptadas à potência disponível	Функция контроля мощности Power Control: регулировка скорости лебедок в зависимости от доступной мощности
⚠	Document commercial non contractuel. Pour toute information technique se référer à la notice correspondante.	Unverbindliches Vertriebsdokument. Für technische Informationen, siehe die entsprechenden Anweisungen.	This commercial document is not legally binding. For any technical information, please refer to the corresponding instructions.	Documento comercial no contractual. Para cualquier información técnica, ver la noticia correspondiente.	Documento commerciale non vincolante, per tutte le informazioni tecniche fare riferimento al catalogo istruzioni.	Documento comercial não contractual. Para qualquer informação técnica complementar consultar as respectivas instruções.	Этот коммерческий документ не является юридически обязательным. Для получения технической информации, см. соответствующие инструкции.

JFM
Équipement de chantier
 ZA RIVE OUEST - Bd de L'Odet - 35741 PACE
 Tél : 02 99 60 25 57 / contact.jfm@jfm.fr
 www.jfm.fr

